

# ROLLERI

TOOLING LAB

LASER CONSUMABLES

PUNCHING TOOLS - IRON WORKER

SHEAR BLADES

PANEL BENDING TOOLS

## BENDING

ROLLA-V DIES  
SPECIAL DIES

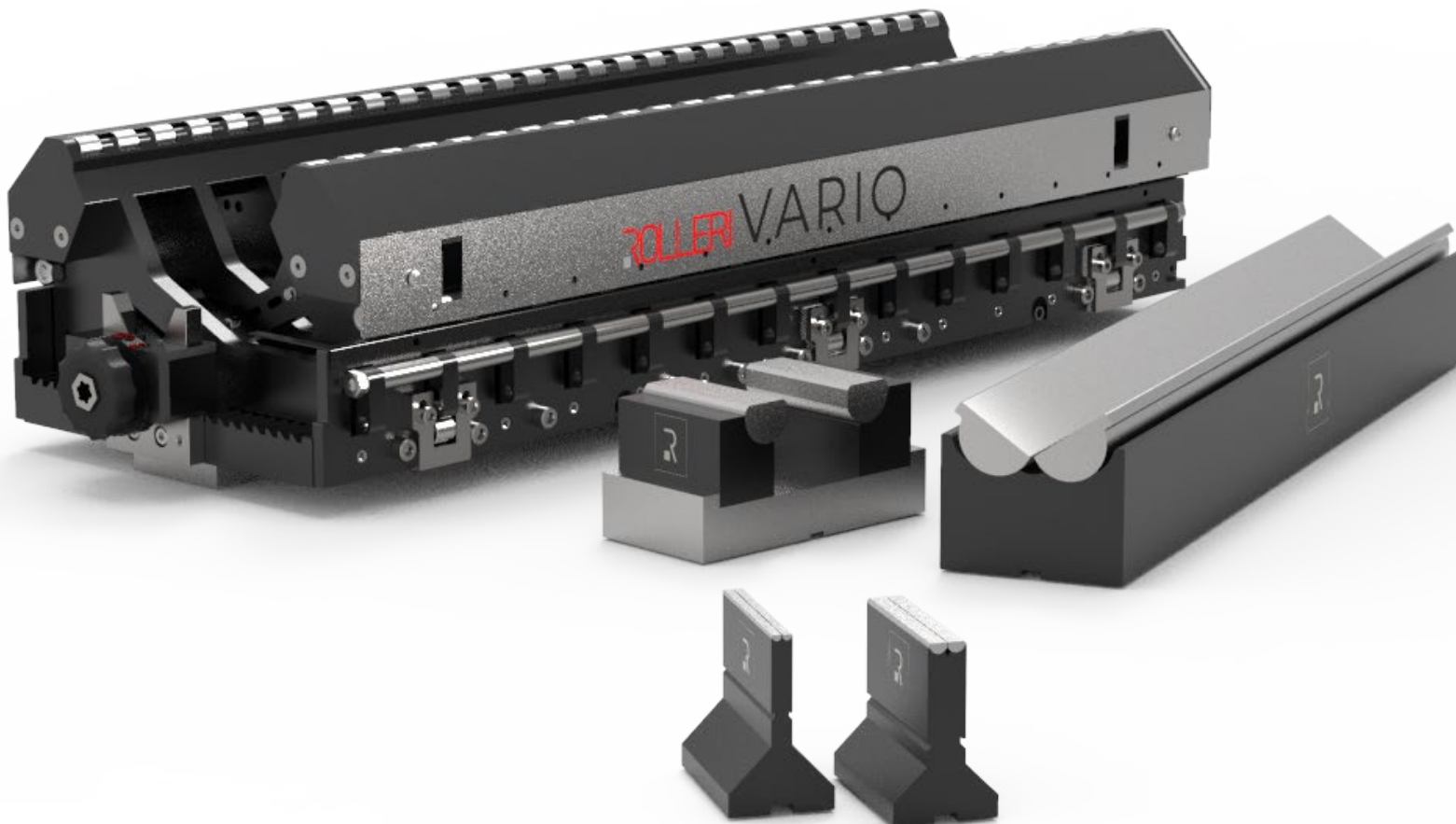



ISO 9001 - ISO 45001  
CERTIFIED  
COMPANY



Click on QR codes or scan them to watch videos. Follow our official Youtube channel [www.youtube.com/Rollerispa](http://www.youtube.com/Rollerispa) or watch videos in our website <https://www.rolleritools.com/media>



#### Download Rolleri **Bending App**

It contains not only a lot of interesting contents but also sheet metal development calculator and bending ruler. Furthermore this free app contains a useful tool to scan the QR codes in this catalogue.



Ask for our punching tooling, ironworker, laser consumables, panel bending tooling and shear blades catalogues at [www.rolleritools.com/download](http://www.rolleritools.com/download)



The **Bending handbook** target is to supply practice and useful information to reach quickly the required result. A lot of examples, easy formulas and information which explain the proper attitude towards the bending process.



Create your account on [www.rolleritools.com](http://www.rolleritools.com)  
You can use Rolleri website to check the delivery time, request quotes, stay update with the news, check prices and place orders directly.



Click on the QR code or scan it to find prices and availability. Create your account on [www.rolleritools.com](http://www.rolleritools.com)



Check standard available sectioning.  
You can also ask for customized tool sectioning. Contact [sales@rolleri.it](mailto:sales@rolleri.it) to ask for feasibility and for customized products.



#### Download Rolleri **Clamping App**

Rolleri App contains a lot of useful information about our fast clamping systems, details for their installation and all user manuals.



## BENDING TOOLS

### R1 TOOLS TYPE

Compatible with press brakes: Accurl, Accurpress, ACL, Adira, Amada, Atlantic, Baykal, BL, Boschert, Boutillon, Bystronic, Beyeler, Euro-B, Coastone, Colgar, Dener, Deratech, Durmazlar, Ermaksan, Farina, Gade, Gasparini, Gecko, Gilardi, Gizelis, Haco, Hindustan, HPM, Iturraspe, Jfy, JMT, LFK, Metfab, MVD, Oriance, Prima Power, Promecam, Rico, Salvagnini, Schiavi, SMD, Sorg, Somo, Vicla, Vimercati, Warcom, Yawei,...

### R2-R3 TOOLS TYPE

Compatible with press brakes: Darley, LVD, Safan, Trumpf and press brakes with NSCL system, Bystronic Beyeler RFA, RF, R, S

### R4 TOOLS TYPE

Compatible with press brakes: LVD

### R5 TOOLS TYPE

Compatible with press brakes: American

### R6 TOOLS TYPE

Compatible with press brakes: Hämmerle-Bystronic

### R7 TOOLS TYPE

Compatible with press brakes: Colly

### R8 TOOLS TYPE

Compatible with press brakes: Colgar

### R9 TOOLS TYPE

Compatible with press brakes: Gasparini (axial)

### R10 TOOLS TYPE

Compatible with press brakes: Ajial Axial

### Rx TOOLS TYPE

Compatible with press brakes: EHT, Ursviken and Weinbrenner

### ROLLERI TECH, MODIFICATIONS AND SERVICES

Compatible with all types of press brakes

### CLAMPING SYSTEMS, INTERMEDIATES AND ADAPTERS

Compatible with all types of press brakes

### ROLLA-V AND SPECIAL DIES

Compatible with all types of press brakes

### MARK FREE BENDING AND ACCESSORIES

Compatible with all types of press brakes

## PANEL BENDING TOOLS

## SHEAR BLADES

## PUNCHING TOOLS

### R1 TOOLS TYPE

Compatible with punching machines Amada, Amada ABS, Wilson HP, Wilson HP WLS, Mate Ultra Tec

### R2 TOOLS TYPE

Compatible with Trumpf punching machines

### RS TOOLS TYPE

Compatible with Salvagnini punching machines

### SPECIAL TOOLS

Compatible with different types of punching machines

### ACCESSORIES

Compatible with different types of punching machines

### IRON WORKER

Iron cutting tools

## LASER CONSUMABLES

Find our wide range of laser consumables: one of the widest in the market.

---

# 6 ROLLA-V DIES

8 - ROLLA-V EXPLANATION

12 - RVP SERIE

13 - RVS SERIE

14 - RVT55-60 SERIE

15 - RVT100 SERIE

16 - RVT90 SERIE

17 - RVM SERIE

19 - ADJUSTABLE DIES SERIE

22 - XT SERIE

24 - ACCESSORI E RICAMBI

# 24 SPECIAL DIES

28 - ROLLERI VARIO

30 - ADJUSTABLE DIES

32 - ADJUSTABLE DIES: BARS

34 - DIES WITH ROLLERS

<b>A</b>		
A10	34	
A11	34	
A13	34	
AD25.125	30	
ad65.185	31	
AD120.300	31	
AD150.400	31	
<b>B</b>		
BAR AD25.185	32	
BAR AD120.300	32	
BAR AD150.400	32	
<b>H</b>		
had25.125	33	
HAD65.185	33	
HAD120.300	33	
HAD150.400	33	
<b>M</b>		
MR90.20.78	35	
MR90.24.78	35	
MR90.30.78	35	
MR90.40.78	35	
MR90.50.78	35	
MR90.60.78	35	
MR90.70.78	35	
MR130.20.78	35	
MR130.24.78	35	
MR130.30.78	35	
MR130.40.78	35	
MR130.50.78	35	
MR130.60.78	35	
MR130.75.78	35	
MR130.80.78	35	
MR130.90.78	35	
MR130.100.78	35	
MR130.120.78	35	
<b>R</b>		
RVHD2	20	
RVHD2.5	20	
RVHD2.5/DO	25	
RVHD2.5/IN	25	
RVHD2.5/SP	25	
RVHD2.5/U	25	
RVHD2/DO	25	
RVHD2/IN	25	
RVHD2/SP	25	
RVHD2/U	25	
RVHD3	20	
RVHD3/DO	25	
RVHD3/IN	25	
RVHD3/SP	25	
RVHD3/U	25	
RVHD4	21	
RVHD4/DO	25	
RVHD4/IN	25	
RVHD4/SP	25	
RVHD4/U	25	
RVM2.5	17	
RVM2.5-12.7	17	
RVM2.5-13	17	
RVM2.5/DO	25	
RVM2.5/IN	25	
RVM2.5/SP	25	
RVM2.5/U	25	
RVM3.5	17	
RVM3.5/DO	25	
RVM3.5/IN	25	
RVM3.5/SP	25	
RVM3.5/U	25	
RVM70-3	18	
RVM70-3-12.7	18	
RVM70-3-13	18	
RVM70-3-60	18	
RVM70-3/DO	25	
RVM70-3/IN	25	
RVM70-3/SP	25	
RVM70-3/U	25	
RVM90-4	18	
RVM90-4-12.7	18	
RVM90-4-13	18	
RVM90-4-60	18	
RVM90-4/DO	25	
RVM90-4/IN	25	
RVM90-4/SP	25	
RVM90-4/U	25	
RVP60-1	12	
RVP60-1/DO	25	
RVP60-1/IN	25	
RVP60-1/SP	25	
RVP60-1/U	25	
RVP65-2	12	
RVP65-2/DO	25	
RVP65-2/IN	25	
RVP65-2/SP	25	
RVP65-2/U	25	
RVP100-3	12	
RVP100-3/DO	25	
RVP100-3/IN	25	
RVP100-3/SP	25	
RVP100-3/U	25	
RVPV3	21	
RVPV3/DO	25	
RVPV3/IN	25	
RVPV3/SP	25	
RVPV3/U	25	
RVS80-1	13	
RVS80-1/DO	25	
RVS80-1/IN	25	
RVS80-1/SP	25	
RVS80-1/U	25	
RVS80-2	13	
RVS80-2/DO	25	
RVS80-2/IN	25	
RVS80-2/SP	25	
RVS80-2/U	25	
RVT55-1	14	
RVT55-1/DO	25	
RVT55-1/IN	25	
RVT55-1/SP	25	
RVT55-1/U	25	
RVT60-2	14	
RVT60-2/DO	25	
RVT60-2/IN	25	
RVT60-2/SP	25	
RVT60-2/U	25	
RVT90-1	16	
RVT90-1/DO	25	
RVT90-1/IN	25	
RVT90-1/SP	25	
RVT90-1/U	25	
RVT90-2	16	
RVT90-2/DO	25	
RVT90-2/IN	25	
RVT90-2/SP	25	
RVT90-2/U	25	
RVT100-1	15	
RVT100-1/DO	25	
RVT100-1/IN	25	
RVT100-1/SP	25	
RVT100-1/U	25	
RVT100-2	15	
RVT100-2/DO	25	
RVT100-2/IN	25	
RVT100-2/SP	25	
RVT100-2/U	25	
RVT100-3	15	
RVT100-3/DO	25	
RVT100-3/IN	25	
RVT100-3/SP	25	
RVT100-3/U	25	
RV-TO	24	
rvX1	24	
RVXT-1	23	
RVXT-1/DO	25	
RVXT-1/IN	25	
RVXT-1/SP	25	
RVXT-1/U	25	
RVXT-2	23	
RVXT-2/DO	25	
RVXT-2/IN	25	
RVXT-2/SP	25	
RVXT-2/U	25	
RVX-TAPE	24	

# ROLLA-V DIES

---

Rolla-V dies differ from traditional dies thanks to two rotors where sheet metal lay before being bent. During bending these rotors accompany sheet metal and reduce consistently its friction resistance and the minimum flange. This die type applies the principles of swivel bending and for this reason sheet metal reaction is different. In case there are holes near the bending line, they are not deformed or flared-out.

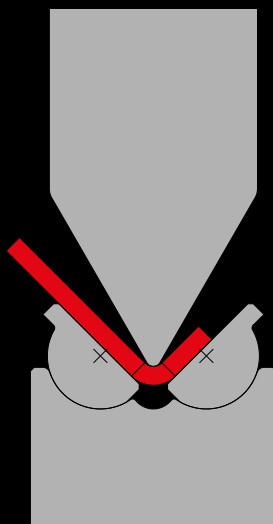

Sheet metal is always supported during bending

Minimum sheet metal movement onto inserts and therefore minimum marks

Internal bending radius equal to punch tip radius

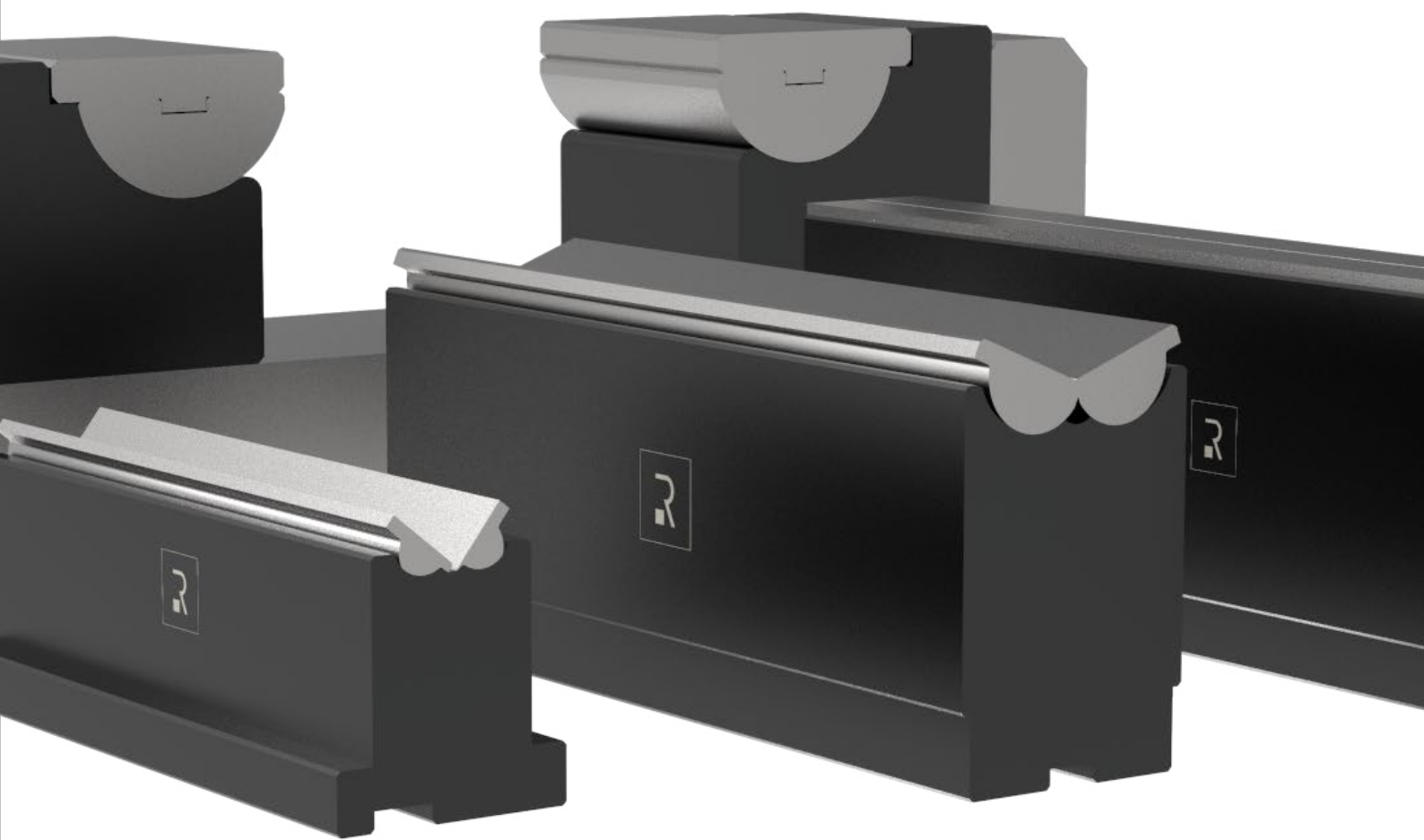

Rolla-V dies have many advantages, but the main reasons for selecting a Rolla-V are:

### Very short flanges

As material utilisation is always a common consideration for modern manufacturers, if it is possible to reduce flange sizes by even 5% this can have significant cost savings for the material bill.

On traditional fixed V dies the edge of the component needs to remain resting on the corner of the die V in order to obtain a good bend with no distortion or flaring.

Also, many components have what we call a “cut-out with a small flange along a longer and larger flange” – for these components, because it is supported during bending, it is possible to achieve very small flange sizes.

### Bending close to holes and slots ,this includes forming tapered or feathered edges ,keeping flaring at the smallest end to a minimal

Some components have tapered or feathered edges which run-out to the bottom of the bend.

Using traditional fixed V dies it is usual for the final parts of the taper flange to flare-out because this part of the flange slips into the fixed V and is unsupported during the bend.

Because the Rolla-V inserts do support the taper flange almost to the bend line, the amount of flare is kept to an absolute minimum and is not usually noticeable.

### Minimal marking

The material is completely supported during bending and therefore, there is no dragging over a vee edge and so the marking is significantly less than traditional bending using standard vees.

Also, because the material has not slid over any ‘edges’ on the die the tram-lining effect will be minimised. This is because the amount of lateral movement between the material and the Rolla-V inserts is very small and is spread over a wide area, so the ‘tram-line’ effect is almost eliminated.

### Eliminate the need for second operations

Many aesthetic components must have a blemish-free surface finish either because the bare metal finish is visible on the final component or the metal has to be painted/powder coated after forming.

The use of time consuming secondary polishing operations can be

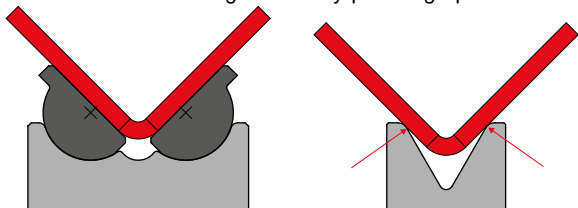

Create your account on [www.rolleritools.com](http://www.rolleritools.com)  
You can use Rolleri website to check the delivery time, request quotes, stay update with the news, check prices and place orders directly.

dramatically reduced if bending with the Rolla-V.

The traditional ‘tramlines’ are not present and any scuffing of other marking is really minimised when comparing a Rolla-V bent component with one bent on traditional fixed V.

No secondary operations, product cost is reduced more importantly delivery time is reduced.

Each of the models has its own maximum outside radii and because the folding action of the tool gives extremely accurate radii's, it wraps itself around the tip on the top punch i.e. if your punch has 1mm nose radii, generally if the material being formed is comfortably working within the parameters of the tool there will be a 1m internal radii in the component.

### ADJUSTABLE ROLLA-V

All advantages described for Rolla-V dies are extended to the adjustable models.

Obviously the adjustable is as it says and the ‘vee size’ is adjustable. Each of the HD models, 2, 2.5, 3 & 4 has its own parameters. Top formers can be supplied individually to form these radii, unfortunately there is not an adjustable top former.

There are 3 types of insert for all of these adjustable models, flat style for normal bending, concave style for producing complete radiused ‘U’ channels in one hit, and finally ‘Pacman’ style inserts to produce flat type channels. One standard bottom tool to do all these.

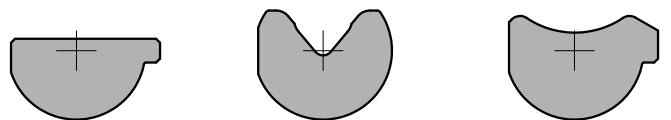

### NON STANDARD ROLLA-V TOOLS

Whilst there is normally a standard Rolla-V to suit most applications, on occasion a project needs to achieve a profile that is outside of standard parameters. As we manufacture every part of the Rolla-V in our “State of the Art” facility we regularly manufacture non standard Rolla-V profiles to suit a specific application.



The **Bending handbook** target is to supply practice and useful information to reach quickly the required result. A lot of examples, easy formulas and information which explain the proper attitude towards the bending process.





The Rolla-V has a complete range of models and each one represents a 'vee' size, which is measured by the centre of the radius inserts. Whether forming 0.5mm to 30mm thick, an outside flange length of 2.7 in 1mm thick material to 40mm in 30mm thick material, there is a Rolla-V die for the operation.

Rolla-V offers a wide die range with different dimensions and is able to bend different sheet metal thicknesses; in fact each model can usually bend 3 different thicknesses. Another important feature is their resistance, as it reaches 2500 kN/m.

All dies are anticorrosion coated and don't need any particular maintenance.

#### EQUIVALENT V SIZE

For each Rolla-V die model you can find the 'vee' size it corresponds to in a normal die. Such equivalent vee size is measured by the centre of its radius inserts.

#### MAX TOOL LOAD

This value represents the max. allowed bending force that each die can stand.

#### MATERIAL THICKNESS

The table shows the sheet metal thickness range that the die can bend. According to the sheet metal thickness you have to bend, find all possible dies you can use and check the following values to find the most suitable die model for your needs.

#### MIN. BENDING ANGLE

For each sheet metal thickness, the table indicates the narrowest angle you can reach by bending that thickness with the selected die model.

#### NEEDED PRESS FORCE

The table indicates the necessary press force to bend the selected mild steel thickness with the selected die.

The formula to calculate the necessary press force in kN/m is:

$$FN \text{ (kN/m)} = \frac{Rm \times (\text{thickness})^2 \times C}{C} \times \left(1 + \frac{4 \times \text{thickness}}{C}\right)$$

**Aluminium: Rm=200-300 N/mm<sup>2</sup>**

**Steel: Rm=370-450 N/mm<sup>2</sup>**

**Stainless: Rm=650-700 N/mm<sup>2</sup>**

Example: 2 mm aluminium with model 2

$$FN \text{ (kN/m)} = \frac{300 \times 2^2}{13.16} \times \left(1 + \frac{4 \times 2}{13.16}\right)$$

Needed press force = 146.62 kN/m

#### MIN. OUTSIDE FLANGE

For each sheet metal thickness, the table indicates the minimum outside edge you can bend by using the selected die model.

$$BEM \text{ (kN/m)} = \sqrt{B^2 / 2}$$

Example: calculation of the min. outside flange with model 1

$$BEM \text{ (kN/m)} = \sqrt{7.17^2 / 2}$$

Minimum edge = 5.07 mm

#### MAX. OUTSIDE RADIUS

For each sheet metal thickness, the table indicates the maximum outside radius you can produce by bending that thickness with the selected die model. If you deduct the sheet metal thickness value from the max. outside radius, you will obtain the max. inside radius and therefore the max. punch tip radius you can use. Bear in mind that during the bending process, the sheet metal is wrapped around the punch tip and tends to produce the internal bending radius equal to the punch tip radius used if its features enable this.

$$\text{Rule 1: } RE \text{ (mm)} = \sqrt{(C^2 / 2) - (s+Z)}$$

**Rule 2: if OUTSIDE RADIUS > B/2.2, ER=B/2.2**

**despite sheet metal thickness, max. outside radius is the result of rule 2. You cannot get a bigger radius than that.**

Example: 3 mm with model 2.5

Rule 1: 17.8 - 5 = 12.8

Rule 2: 26.34 / 2.2 = 11.97

MAX. OUTSIDE RADIUS = 11.97

#### PUNCH TIP RADIUS

To calculate the correct punch tip radius to use according to the outside radius, use the following formula:

**Model 1 and 2**

$$pR = (\text{outside radius} - \text{sheet metal thickness}) \times 0.9$$

**Model 2.5, 3, 3.5 and 4**

$$pR = (\text{outside radius} - \text{sheet metal thickness}) \times 0.8$$



Download or ask for catalogues of punching tooling, ironworker, laser consumables, panel bending tooling and shear blades at [www.rolleritools.com/download](http://www.rolleritools.com/download)



Download Roller Bending App.

Further to many interesting contents, the free app contains the tool for sheet metal development calculation and bending ruler.

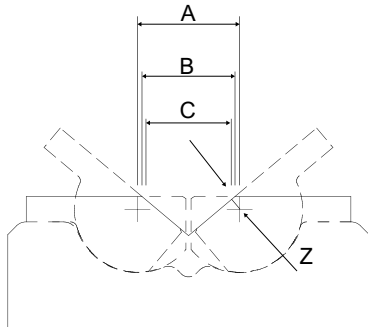

Model	A		B		C		Z	
	mm	in	mm	in	mm	in	mm	in
XT1	5.7	0.22	5.04	0.2	4.57	0.18	0.8	0.03
XT2	10	0.39	9.21	0.36	8.66	0.34	0.95	0.04
Model 1	8	0.31	7.17	0.28	6.59	0.26	1	0.04
Model 2	15	0.59	13.92	0.55	13.16	0.52	1.3	0.05
Model 2.5	28	1.1	26.34	1.04	25.17	0.99	2	0.08
Model 3	38	1.5	33.44	1.32	30.22	1.19	5.5	0.22
Model 3.5	60	2.36	57.1	2.25	55.05	2.17	3.5	0.14
Model 4	85	3.35	80.03	3.15	76.51	3.01	6	0.24

	with V		Max. tool load (kN/m)	Material Thickness		Min. bending angle	Needed press force mild steel with max. 450 N/mm <sup>2</sup> (kN/m)	Needed press force stainless steel with max. 700 N/mm <sup>2</sup> (kN/m)	Min. outside flange		Max. outside radius	
	mm	in		mm	in				mm	in	mm	in
<b>Model XT1</b> Max. recommended thickness = 1.2 mm 0.05	5.7	0.22	500	0.5	0.02	60°	50	75	2.7	0.11	1.7	0.07
				1.0	0.04	60°	180	260	4.0	0.16	1.3	0.05
<b>Model XT2</b> Max. recommended thickness = 2.3 mm 0.09	10	0.39	500	1.2	0.05	60°	120	170	4.9	0.19	3.3	0.13
				2.0	0.79	60°	320	450	6.0	0.24	2.4	0.09
<b>Model 1</b> Max. recommended thickness = 1.5 mm 0.06	8	0.31	1000	0.7	0.03	40°	50	70	3	0.12	3	0.12
				1.1	0.04	35°	130	200	3.9	0.15	2.6	0.1
				1.5	0.06	35°	270	410	4.2	0.17	2.2	0.09
<b>Model 2</b> Max. recommended thickness = 3.2 mm 0.12	15	0.59	1500	2	0.08	59°	210	320	8.5	0.33	6	0.24
				3	0.12	47°	550	850	9.3	0.37	5	0.2
				3.2	0.13	47°	650	1000	9.3	0.37	4.8	0.19
<b>Model 2.5</b> Max. recommended thickness = 6.3 mm 0.25	28	1.1	2500	2	0.08	46°	100	150	18.6	0.73	13.2	0.52
				4	0.16	46°	470	730	18.6	0.73	12	0.47
				6	0.24	55°	1270	1960	18.6	0.73	9.8	0.39
<b>Model 3</b> Max. recommended thickness = 6.3 mm 0.25	38	1.5	2500	2	0.08	68°	70	110	22.5	0.89	13.9	0.55
				4	0.16	47°	340	500	22.5	0.89	11.9	0.47
				6	0.24	50°	900	1300	22.5	0.89	9.9	0.39
<b>Model 3.5</b> Max. recommended thickness = 8 mm 0.31"	60	2.36	2500	6	0.24	75°	440	610	39	1.53	20	0.79
				8	0.31	75°	850	1190	39	1.53	20	0.79
<b>Model 4</b> Max. recommended thickness = 16 mm 0.63	85	3.35	3000	6	0.24	78°	260	440	56.6	2.23	36.4	1.43
				8	0.31	76°	500	840	56.6	2.23	36.4	1.43
				12	0.47	73°	1290	2150	56.6	2.23	36.4	1.43



Click the QRCode or scan it to watch a video and find out more about ROLLA-V dies.



Find out all accessories for Rolla-V dies, check prices and order quickly online. Visit the dedicated section and create your account [www.rolleritools.com](http://www.rolleritools.com)



**COMPATIBILITY**

tools serie	R1	R2	R3	R4	R5
RVP	●	-	-	-	-
RVS	○	-	-	-	-
RVT55-60	-	●	●	-	○
RVT100	-	●	●	-	○
RVT90	-	-	-	●	-
RVM	○	○	○	○	○
RVHD-RVPV	○	○	○	○	○
XT	●	○	○	-	-

○ available for some models only or on request with modifications

**STANDARD LENGTH**

serie length	RVP	RVS	RVT 55-60	RVT 100	RVT 90	RVM	RVHD RVPV	XT
50 mm   1.97"	-	-	-	-	-	-	-	●
100 mm   3.94"	-	-	-	-	-	-	-	●
200 mm   7.87"	-	-	-	-	-	-	-	●
250 mm   9.84"	-	-	-	-	-	-	●	-
500 mm   19.68"	●	●	●	●	●	●	●	●

**ROTORS MATERIAL**

material	model	1	2	2.5	3	3.5	4	XT
LR 606 through hardened and triple tempered to give hardness of 54-56 HRC		●	●	-	-	-	-	●
D2 through hardened in a Vacuum to 61 HRC (Rockwell)		-	-	●	●	●	●	-

All measurements using HRc hardness are accurate to within 2 points.

**SEGMENTATION**

single segments are also available on request - contact [sales@rolleri.it](mailto:sales@rolleri.it) to know more about price and availability

Model 1 and XT Serie: 440 mm - 17.32"  
mm: 200-100-50-30-25-20-15  
in: 7.87-3.94-1.97-1.18-0.98-0.79-0.59



Model 2: 450 mm - 17.72"  
mm: 200-100-40-35-30-25-20  
in: 7.87-3.94-1.57-1.38-1.18-0.98-0.79



Model 2.5: 470 mm - 18.50"  
mm: 200-100-50-45-40-35  
in: 7.87-3.94-1.97-1.77-1.57-1.38



Model 3: 455 mm - 17.91"  
mm: 200-100-60-50-45  
in: 7.87-3.94-2.36-1.97-1.77

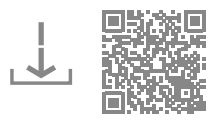

Download or ask for catalogues of punching tooling, ironworker, laser consumables, panel bending tooling and shear blades at [www.rolleritools.com/download](http://www.rolleritools.com/download)



Create your account on [www.rolleritools.com](http://www.rolleritools.com)  
You can use Rolleri website to check the delivery time, request quotes, stay update with the news, check prices and place orders directly.

**RVP60-1**

500 mm 16.68" 6.9 kg  
 440 mm 17.32" 6.1 kg F

**Model 1**



42Cr: 900-1150 N/mm<sup>2</sup>  
 1500 kN/m max.

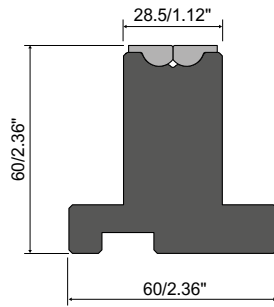

**RVP65-2**

500 mm 16.68" 7.9 kg  
 450 mm 17.72" 7.4 kg F

**Model 2**



42Cr: 900-1150 N/mm<sup>2</sup>  
 1500 kN/m max.

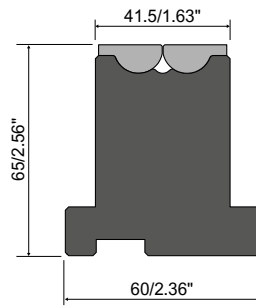

**RVP100-3**

500 mm 16.68" 28.8 kg  
 455 mm 17.91" 26.2 kg F

**Model 3**



42Cr: 900-1150 N/mm<sup>2</sup>  
 2500 kN/m max.

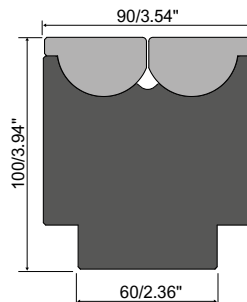

Model 1: 440 mm - 17.32"  
 mm: 200-100-50-30-25-20-15  
 in: 7.87-3.94-1.97-1.18-0.98-0.79-0.59



Model 2: 450 mm - 17.72"  
 mm: 200-100-40-35-30-25-20  
 in: 7.87-3.94-1.57-1.38-1.18-0.98-0.79



**RVS80-1**

500 mm 19.68" 6.3 kg  
 440 mm 17.32" 5.8 kg F

**Model 1**



42Cr: 900-1150 N/mm<sup>2</sup>  
 1000 kN/m max.

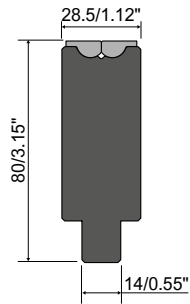

**RVS80-2**

500 mm 19.68" 8.3 kg  
 450 mm 17.72" 7.8 kg F

**Model 2**



42Cr: 900-1150 N/mm<sup>2</sup>  
 1500 kN/m max.

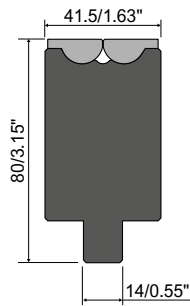

Model 3: 455 mm - 17.91"  
 mm: 200-100-60-50-45  
 in: 7.87-3.94-2.36-1.97-1.77



Click the QRCode or scan it to watch a video and find out more about ROLLA-V dies.

**RVT55-1**

500 mm 19.68" 5.5 kg  
 440 mm 17.32" 5.0 kg F

**Model 1**



42Cr: 900-1150 N/mm<sup>2</sup>  
 1000 kN/m max.

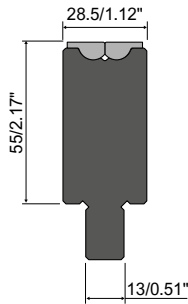

**RVT60-2**

500 mm 19.68" 7.9 kg  
 450 mm 17.72" 7.4 kg F

**Model 2**



42Cr: 900-1150 N/mm<sup>2</sup>  
 1500 kN/m max.

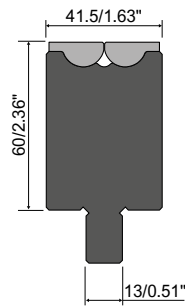

Model 1: 440 mm - 17.32"  
 mm: 200-100-50-30-25-20-15  
 in: 7.87-3.94-1.97-1.18-0.98-0.79-0.59



Model 2: 450 mm - 17.72"  
 mm: 200-100-40-35-30-25-20  
 in: 7.87-3.94-1.57-1.38-1.18-0.98-0.79



RVT100-1

500 mm 19.68" 9.4 kg  
440 mm 17.32" 8.6 kg F

Model 1



42Cr: 900-1150 N/mm<sup>2</sup>  
1000 kN/m max.

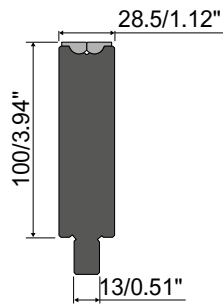

RVT100-2

500 mm 19.68" 12.4 kg  
450 mm 17.72" 11.7 kg F

Model 2



42Cr: 900-1150 N/mm<sup>2</sup>  
1500 kN/m max.

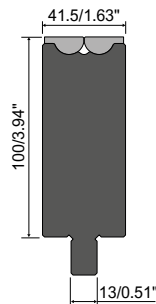

RVT100-3

500 mm 19.68" 30.9 kg  
455 mm 17.91" 28.5 kg F

Model 3



42Cr: 900-1150 N/mm<sup>2</sup>  
2500 kN/m max.

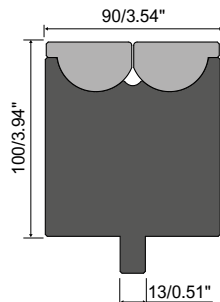

Model 3: 455 mm - 17.91"  
mm: 200-100-60-50-45  
in: 7.87-3.94-2.36-1.97-1.77



Click the QRCode or scan it to watch a video and find out more about ROLLA-V dies.

**RVT90-1**

500 mm 19.68" 9.4 kg  
 440 mm 17.32" 7.8 kg F

**Model 1**



42Cr: 900-1150 N/mm<sup>2</sup>  
 1000 kN/m max.

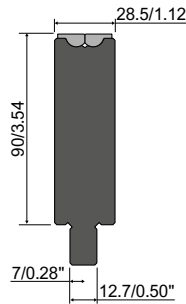

**RVT90-2**

500 mm 19.68" 11.3 kg  
 450 mm 17.72" 10.6 kg F

**Model 2**



42Cr: 900-1150 N/mm<sup>2</sup>  
 1500 kN/m max.

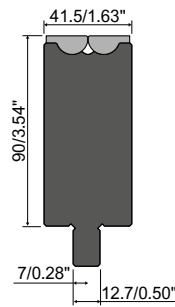

Model 1: 440 mm - 17.32"  
 mm: 200-100-50-30-25-20-15  
 in: 7.87-3.94-1.97-1.18-0.98-0.79-0.59



Model 2: 450 mm - 17.72"  
 mm: 200-100-40-35-30-25-20  
 in: 7.87-3.94-1.57-1.38-1.18-0.98-0.79





**RVM2.5**

**Without tang**

500 mm 19.68" 22.0 kg  
 470 mm 18.50" 21.0 kg F

42Cr: 900-1150 N/mm<sup>2</sup>  
 2500 kN/m max.

**Model 2.5**

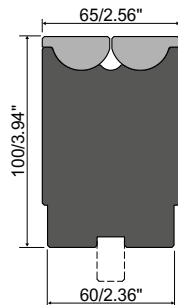

**RVM2.5-13 / RVM2.5-12.7**

**With tang 13 mm 0.51"**

500 mm 19.68" 23.5 kg  
 470 mm 18.50" 22.4 kg F

**With tang 12.7 0.5"**

500 mm 19.68" 23.5 kg  
 470 mm 18.50" 22.4 kg F

42Cr: 900-1150 N/mm<sup>2</sup>  
 2500 kN/m max.



**RVM3.5**

500 mm 19.68" 44.0 kg  
 250 mm 9.84" 22.0 kg

42Cr: 900-1150 N/mm<sup>2</sup>  
 2800 kN/m max.

**NEW**

**Model 3.5**

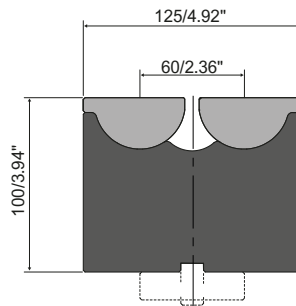

Model 2.5: 470 mm - 18.50"  
 mm: 200-100-50-45-40-35  
 in: 7.87-3.94-1.97-1.77-1.57 -1.38



Click the QRCode or scan it to watch a video and find out more about ROLLA-V dies.

**RVM70-3 / RVM70-3-60**



**Model 3**

**Without tang**

500 mm 19.68" 20.6 kg  
455 mm 17.91" 18.7 kg F

**With tang 60 mm 2.36"**

500 mm 19.68" 23.5 kg  
455 mm 17.91" 23.0 kg F

42Cr: 900-1150 N/mm<sup>2</sup>  
2500 kN/m max.

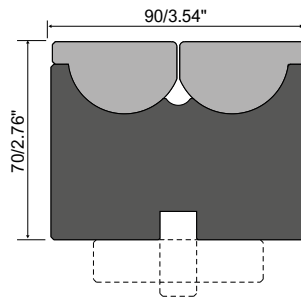

**RVM70-3-13 / RVM70-3-12.7**



**With tang 13 mm 0.51"**

500 mm 19.68" 22.1 kg  
455 mm 17.91" 20.1 kg F

**With offset tang 12.7 0.5"**

500 mm 19.68" 22.1 kg  
455 mm 17.91" 20.1 kg F

42Cr: 900-1150 N/mm<sup>2</sup>  
2500 kN/m max.

**RVM90-4 / RVM90-4-60**



**Model 4**

**Without tang**

500 mm 19.68" 56.6 kg  
250 mm 9.84" 22.7 kg

**With tang 60 mm 2.36"**

500 mm 19.68" 61.3 kg  
250 mm 9.84" 24.6 kg

42Cr: 900-1150 N/mm<sup>2</sup>  
3000 kN/m max.

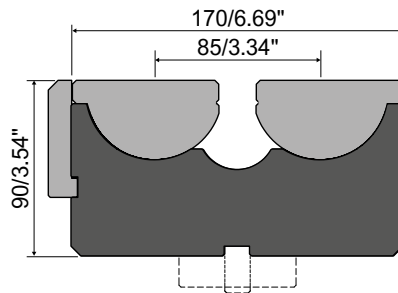

**RVM90-4-13 / RVM90-4-12.7**



**With tang 13 mm 0.51"**

500 mm 19.68" 58.1 kg  
250 mm 9.84" 23.3 kg

**With offset tang 12.7 0.5"**

500 mm 19.68" 58.1 kg  
250 mm 9.84" 23.3 kg

42Cr: 900-1150 N/mm<sup>2</sup>  
3000 kN/m max.

Model 3: 455 mm - 17.91"  
mm: 200-100-60-50-45  
in: 7.87-3.94-2.36-1.97-1.77



Click the QRCode or scan it to watch a video and find out more about ROLLA-V dies.



ADJUSTABLE ROLLA-V DIES

All advantages described for Rolla-V dies are extended to the adjustable models.

Obviously the adjustable is as it says and the 'vee size' is adjustable. Each of the HD models, 2, 2.5, 3 & 4 has its own parameters. Top formers can be supplied individually to form these radii, unfortunately there is not an adjustable top former.

There are 3 types of insert for all of these adjustable models, flat style for normal bending, concave style for producing complete radiused 'U' channels in one hit, and finally 'Pacman' style inserts to produce flat type channels. One standard bottom tool to do all these.

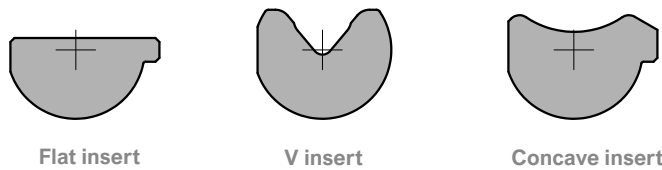
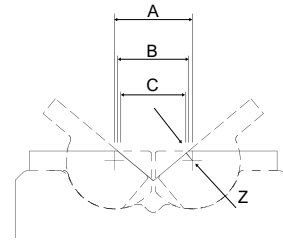

Model	A		B		C		Z	
	mm	in	mm	in	mm	in	mm	in
RVHD2	30	1.18	29	1.14	28.2	1.11	1.3	0.05
RVHD2.5	69	2.72	67.3	2.65	66.2	2.61	2.0	0.08
RVHD3	118	4.65	113.4	4.46	110.2	4.34	5.5	0.22
RVHD4	220	8.66	215	8.46	211.5	8.33	6.0	0.24

Model	A		B		C		Z	
	mm	in	mm	in	mm	in	mm	in
RVHD2	16	0.63	15	0.59	14.2	0.56	1.3	0.05
RVHD2.5	28	1.1	26.3	1.04	25.2	0.99	2.0	0.08
RVHD3	38	1.5	33.4	1.31	30.2	1.19	5.5	0.22
RVHD4	68.5	2.7	63.5	2.5	60	2.36	6.0	0.24

Model	Max. load kN/m	Min. equivalent Vee - Flat Insert		Max. equivalent Vee - Flat insert		Max. Material Thickness - Flat Insert		Min. Outside Radius - Concave Insert		Max. Outside Radius - Concave Insert		Max. Material Thickness - Concave Insert		V Insert equivalent vee		Minimum Channel Width - V Insert		Maximum Channel Width - V Insert		Min/Max External Corner Radius - V insert		MAX Material Thickness - V Insert	
		mm	in	mm	in	mm	in	mm	in	mm	in	mm	in	mm	in	mm	in	mm	in	mm	in	mm	in
RVHD2	2000	14	0.55	28	1.10	5	0.19	8	0.31	12	0.47	2	0.07	10	0.39	18.5	0.72	31.75	1.25	2.5-4	0.09-0.15	1.5	0.06
RVHD2.5	2500	25	0.98	65	2.56	10	0.39	15	0.59	27	1.06	4	0.15	18	0.71	35	1.38	72	2.83	4-9	0.15-0.35	2	0.07
RVHD3	3500	30	1.18	110	4.33	16	0.63	20	0.78	40	1.57	8	0.31	25	0.98	45	1.77	120	4.72	5-12	0.19-0.47	3	0.11
RVHD4	3500	60	2.36	210	8.27	26	1.02	40	1.57	65	2.56	12	0.47	40	1.57	72.5	2.85	220	8.66	5-20	0.19-0.78	5	0.19

The present table is a guideline only and specific tests are recommended. For further information contact [tecnico@rolleri.it](mailto:tecnico@rolleri.it) and get the correct parameters.

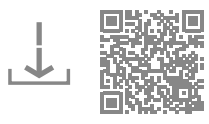
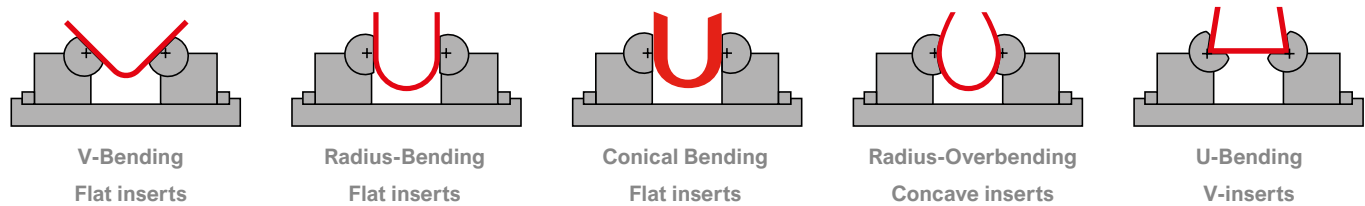

Download or ask for catalogues of punching tooling, ironworker, laser consumables, panel bending tooling and shear blades at [www.rolleritools.com/download](http://www.rolleritools.com/download)



Create your account on [www.rolleritools.com](http://www.rolleritools.com). You can use Rolleri website to check the delivery time, request quotes, stay update with the news, check prices and place orders directly.

### RVHD2

500 mm 19.68" 67.5 kg  
250 mm 9.84" 27 kg

42Cr: 900-1150 N/mm<sup>2</sup>  
2000 kN/m max.

V range  
mm: 13.2 - 28.2  
in: 0.52 - 1.11  
**NEW**

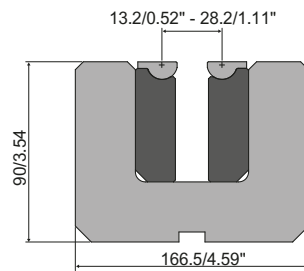

### RVHD2.5

500 mm 19.68" 67.5 kg  
250 mm 9.84" 27 kg

42Cr: 900-1150 N/mm<sup>2</sup>  
2500 kN/m max.

V range  
mm: 28 - 69  
in: 1.10 - 2.72

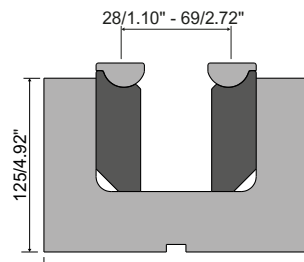

### RVHD3

500 mm 19.68" 98 kg  
250 mm 9.84" 38.1 kg

42Cr: 900-1150 N/mm<sup>2</sup>  
3500 kN/m max.

V range  
mm: 39 - 118  
in: 1.53 - 4.65

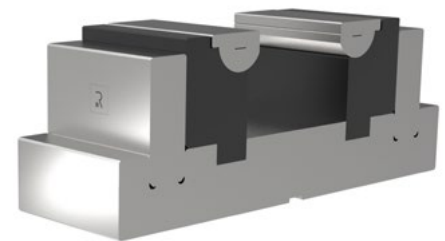
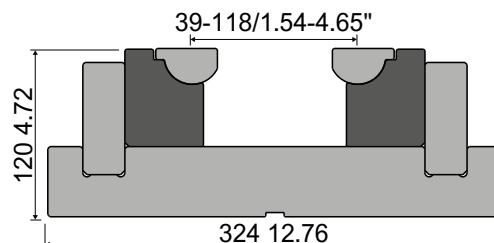

**RVX1** grease is a lithium-based lubricant with specific properties. Thanks to its additives it can bear high work load generated by compression; it protects components undergoing friction, therefore it is suitable to protect rotors seat and avoid abrasion.



Find out all accessories for Rolla-V dies, check prices and order quickly online. Visit the dedicated section and create your account [www.rolleritools.com](http://www.rolleritools.com)

### RVHD4

500 mm 19.68" 200 kg  
250 mm 9.84" 80 kg

42Cr: 900-1150 N/mm<sup>2</sup>  
4000 kN/m max.

V range  
mm: 70 - 220  
in: 2.76 - 8.66

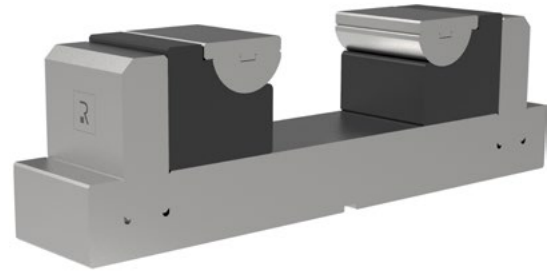
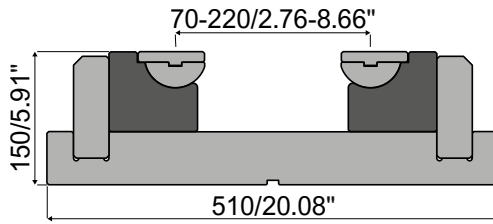

### RVPV3

500 mm 19.68" 98.0 kg  
250 mm 9.84" 38.1 kg

42Cr: 900-1150 N/mm<sup>2</sup>  
2500 kN/m max.

V range  
mm: 39 - 94  
in: 1.53 - 3.70

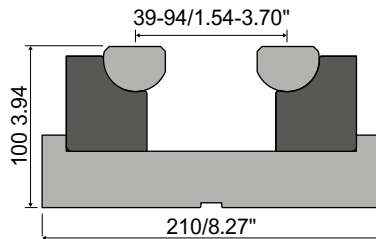

### HANDLES INCLUDED

In order to move easily dies model RVPV3 and RVHD series, dies are equipped with two handles which can be screwed to threaded holes already drilled in the die. Such handles can be used for manual handling (when weight limit enables it) and for mechanical handling.

Thanks to this solution, die positioning and removal is easy and safe.

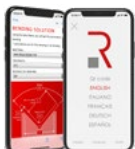

Download Roller Bending App.

Further to many interesting contents, the free app contains the tool for sheet metal development calculation and bending ruler.



Click the QRCode or scan it to watch a video and find out more about ROLLA-V dies.

Rolla-V XT dies are suitable to:

- Make tight counterbends thanks to their thin stem
- Bend profiles with deformations near the bending line
- Bend shorter flanges than with conventional dies
- Bend feathered sides without flaring
- Bend profiles with holes or slots near the bending line without deformation.

Reference value for minimum flange: Mild steel

	RVXT-1				RVXT-2			
	mm	in	mm	in	mm	in	mm	in
Radius of the punch/top-tool	R0.5	R0.019	R1.0	R0.039	R0.5	R0.019	R1.0	R0.039
Material thickness 0.5 mm 0.019"	2.7	0.10	2.9	0.11				
Material thickness 0.8 mm 0.031"	3.2	0.12	3.1	0.12	4.9	1.19	4.7	0.18
Material thickness 1.0 mm 0.039"	3.5	0.14	3.6	0.14	5.5	0.22	5.4	0.21
Material thickness 1.5 mm 0.059"					6.0	0.24	6.1	0.24
Material thickness 2.0 mm 0.078"					5.8	0.23	6.6	0.26

Table of force: Tensile strength Rm = 450 N/mm2, bending angle 90°

	RVXT-1				RVXT-2					
	mm	in	mm	in	mm	in	mm	in	mm	in
Raggio del punzone	R0.2	R0.007	R1.0	R0.039	R0.2	R0.007	R1.0	R0.039	R3.0	R0.11
Material thickness 0.3 mm 0.01"	40	1.57	50	1.96	40	1.57	50	1.96	50	1.96
Material thickness 0.5 mm 0.019"	50	1.96	60	2.36	50	1.96	50	1.96	50	1.96
Material thickness 0.8 mm 0.031"	100	3.93	130	5.11	70	2.75	80	3.15	90	3.54
Material thickness 1.0 mm 0.039"	150	5.90	190	7.48	80	3.15	100	3.93	130	5.11
Material thickness 1.2 mm 0.04"	240	9.45	300	11.81	110	4.33	140	5.51	180	7.08
Material thickness 1.6 mm 0.06"					200	7.87	220	8.66	250	9.84
Material thickness 2.0 mm 0.078"					300	11.81	330	12.99		
Material thickness 2.3 mm 0.09"					400	15.74	420	16.53		

For mark free applications apply **RVX-TAPE** onto Rolla-V dies. This adhesive tape is made of a composite material able to resist compression and at the same time to avoid friction between sheet metal and die.



Find out all accessories for Rolla-V dies, check prices and order quickly online. Visit the dedicated section and create your account [www.rolleritools.com](http://www.rolleritools.com)

**RVXT-1**



50 mm	1.97"	0.2 kg	
100 mm	3.94"	0.4 kg	
200 mm	7.87"	0.9 kg	
500 mm	19.68"	2.1 kg	
440 mm	17.32"	1.9 kg	F

42Cr: 900-1150 N/mm<sup>2</sup>  
500 kN/m max.

**NEW**

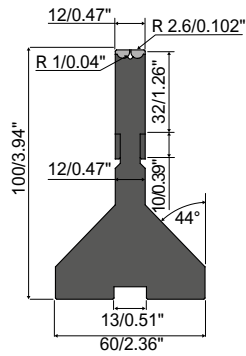

**RVXT-2**



50 mm	1.97"	1.0 kg	
100 mm	3.94"	2.0 kg	
200 mm	7.87"	4.0 kg	
500 mm	19.68"	10.0 kg	
440 mm	17.32"	8.8 kg	F

42Cr: 900-1150 N/mm<sup>2</sup>  
500 kN/m max.

**NEW**

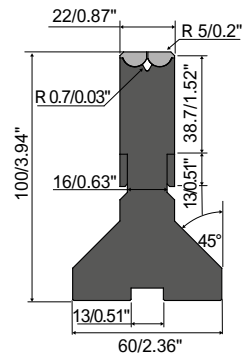

Model 1: 440 mm - 17.32"

mm: 200-100-50-30-25-20-15

in: 7.87-3.94-1.97-1.18-0.98-0.79-0.59



Click the QRCode or scan it to watch a video and find out more about ROLLA-V dies.

---

**RVX1**

---

**GREASE**

RVX1 grease is a lithium-based lubricant with specific properties. Thanks to its additives it can bear high work load generated by compression; it protects components undergoing friction, therefore it is suitable to protect rotors seat and avoid abrasion. A single pack contains 500g grease.

---

**RVX-TAPE**

---

**PROTECTION**

For mark free applications apply RVX-TAPE with width 12mm 0.47" or 20mm 0.79" onto Rolla-V dies. This adhesive tape is made of a composite material able to resist compression and at the same time to avoid friction between sheet metal and die.

---

**RV-TO**

---

**MOUNTING TOOL**

This tool has been designed to remove easily a spring from its dowel. Thanks to its shape, RV-TO can carry out this operation safely and replace worn parts very quickly.



Click the QRCode or scan it to watch a video and find out more about ROLLA-V dies.



Create your account on [www.rolleritools.com](http://www.rolleritools.com)  
You can use Rolleri website to check the delivery time, request quotes, stay update with the news, check prices and place orders directly.



Compatibility	Tongs	Inserts	Lower spines	U clip
RVP60-1	RVP60-1/SP	RVP60-1/IN	RVP60-1/DO	RVP60-1/U
RVP65-2	RVP65-2/SP	RVP65-2/IN	RVP65-2/DO	RVP65-2/U
RVP100-3	RVP100-3/SP	RVP100-3/IN	RVP100-3/DO	RVP100-3/U
RVS80-1	RVS80-1/SP	RVS80-1/IN	RVS80-1/DO	RVS80-1/U
RVS80-2	RVS80-2/SP	RVS80-2/IN	RVS80-2/DO	RVS80-2/U
RVT55-1	RVT55-1/SP	RVT55-1/IN	RVT55-1/DO	RVT55-1/U
RVT60-2	RVT60-2/SP	RVT60-2/IN	RVT60-2/DO	RVT60-2/U
RVT100-1	RVT100-1/SP	RVT100-1/IN	RVT100-1/DO	RVT100-1/U
RVT100-2	RVT100-2/SP	RVT100-2/IN	RVT100-2/DO	RVT100-2/U
RVT100-3	RVT100-3/SP	RVT100-3/IN	RVT100-3/DO	RVT100-3/U
RVT90-1	RVT90-1/SP	RVT90-1/IN	RVT90-1/DO	RVT90-1/U
RVT90-2	RVT90-2/SP	RVT90-2/IN	RVT90-2/DO	RVT90-2/U
RVM2.5	RVM2.5/SP	RVM2.5/IN	RVM2.5/DO	RVM2.5/U
RVM3.5	RVM3.5/SP	RVM3.5/IN	RVM3.5/DO	RVM3.5/U
RVM70-3	RVM70-3/SP	RVM70-3/IN	RVM70-3/DO	RVM70-3/U
RVM90-4	RVM90-4/SP	RVM90-4/IN	RVM90-4/DO	RVM90-4/U
RVHD2	RVHD2/SP	RVHD2/IN	RVHD2/DO	RVHD2/U
RVHD2.5	RVHD2.5/SP	RVHD2.5/IN	RVHD2.5/DO	RVHD2.5/U
RVHD3	RVHD3/SP	RVHD3/IN	RVHD3/DO	RVHD3/U
RVHD4	RVHD4/SP	RVHD4/IN	RVHD4/DO	RVHD4/U
RVPV3	RVPV3/SP	RVPV3/IN	RVPV3/DO	RVPV3/U
RVXT-1	RVXT-1/SP	RVXT-1/IN	RVXT-1/DO	RVXT-1/U
RVXT-2	RVXT-2/SP	RVXT-2/IN	RVXT-2/DO	RVXT-2/U

**NEW**

Download Roller Bending App.

Further to many interesting contents, the free app contains the tool for sheet metal development calculation and bending ruler.



The **Bending handbook** target is to supply practice and useful information to reach quickly the required result. A lot of examples, easy formulas and information which explain the proper attitude towards the bending process.

# SPECIAL DIES

---

Adjustable dies, dies with rollers and the exclusive and patent-pending Rolleri Vario.

Rolleri Vario is a patent-pending adjustable die. Thanks to this solution you can mount one single tool onto a press brake table and change die V opening manually or with CNC.

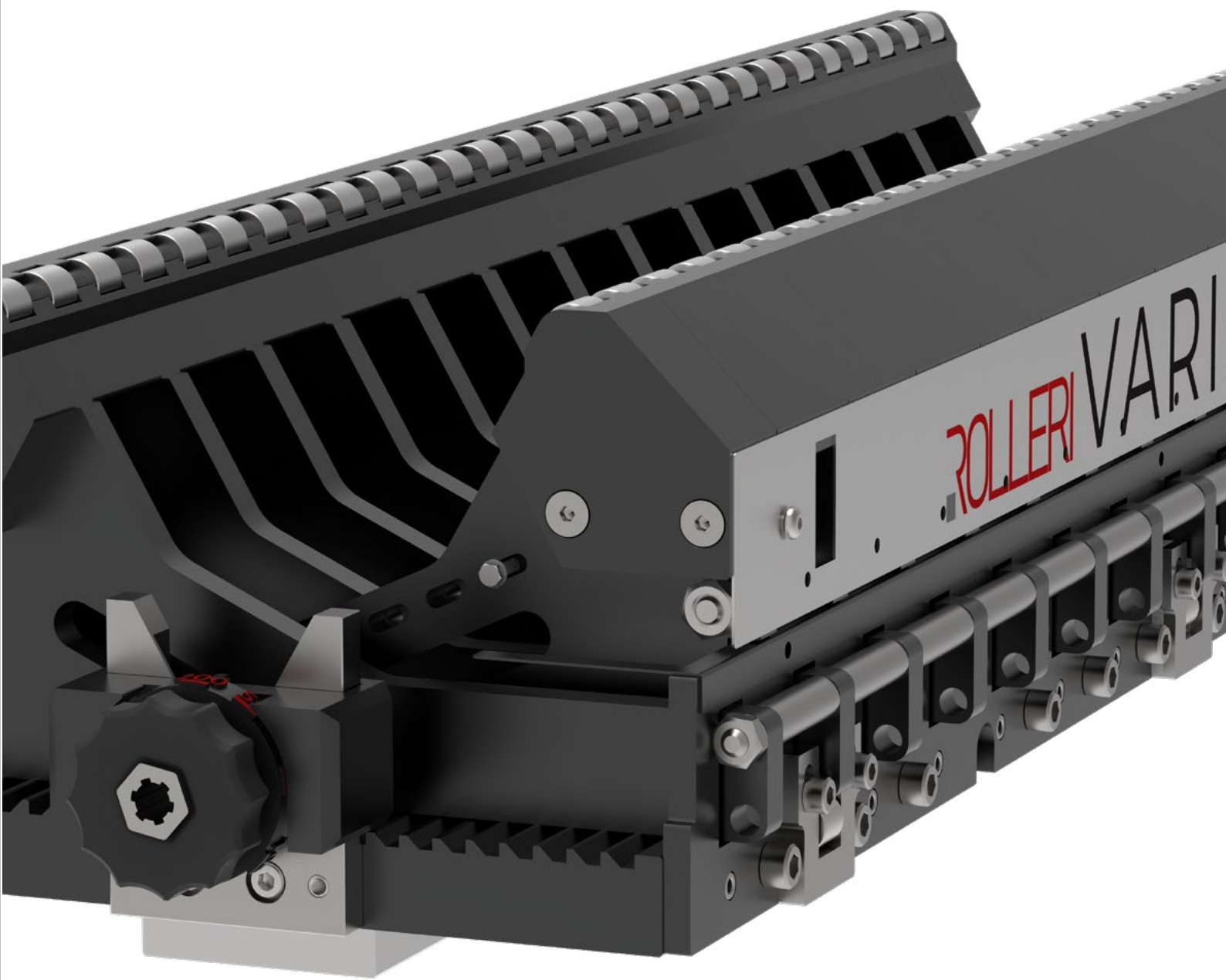

ROLLERI VARI

Rolleri Vario is a patent-pending adjustable die.

Thanks to this solution you can mount one single tool onto a press brake table and change die V opening manually or with CNC.

The main features of Rolleri Vario are easy use, max. load 2500 KN/m, 60° die angle to control better sheet metal springback and its modularization.

Rolleri Vario is manufactured in modules of 1000mm length each, which can be connected to each other and work like a unique die. Minimum length is therefore 1000mm and maximum length depends on press brake length. Rolleri Vario already installed in the market are 4m, 6m, 7m, 8m and 12m long.

A specific feature of Rolleri Vario consists in the possibility to disconnect single modules from each other and use them as single dies with different V openings at the same time. This is very useful for stage bending.

Thanks to its modularization you can get different angles and different internal radii. The operating principle is very easy and handy: a pneumatic system releases the die from its toothed rack positioned on the bottom, so that the V opening needed can be set quickly. Once V opening is adjusted by rotating a round nonium, close compressed air (6bar) so that die sits in the toothed rack and it's ready to bend. To adjust the die from the smallest to the biggest V opening you need about 5 seconds in the manual version. The system is supplied with an acoustic device which signals the correct position of every V opening.

Another remarkable feature of Rolleri Vario is the use of rollers on the V opening edges instead of a fixed radius present in traditional dies. Such rollers are hardened and roll around a central pin, which guarantees rolling also in case of scale.

Rolleri Vario reduces the necessary bending force by about 25-30%. The die is made of heavy duty steel and its base and toothed rack are induction hardened.

The die is also supplied with a protective cloth to be quickly positioned in the V opening in order to protect the internal structure from dust and sheet metal residues.

Rolleri offers dies ranging from V40 up to V 400mm. There are 4 models with max. opening V=200 mm (7.87"), 260 mm (10.23"), 300 mm (11.81") and 400 mm (15.75") and V opening can be adjusted in steps of 20 mm (0.75") or 25 mm (0.98").

Every die can be adjusted manually, with an independent motoreducer and PLC or with a motoreducer connected to press brake CNC.

Rolleri Vario can also be supplied with an adapter positioned in the V opening, which can mount all standard dies in our catalogue.

Rolleri Vario is the synthesis of technology, practicality, safety and time-saving: setup time is reduced by 85%, operators don't have to handle big and heavy tools and the investment is lower than the total amount of single dies.



**VARIO 50 - 200**

mm	in
50	1.97
75	2.95
100	3.94
125	4.92
150	5.90
175	6.89
200	7.87

**VARIO 40 - 260**

mm	in
40	1.57
60	2.36
80	3.15
100	3.94
120	4.72
140	5.51
160	6.23
180	7.09
200	7.87
220	8.66
240	9.45
260	10.23

**VARIO 50 - 300**

mm	in
50	1.97
75	2.95
100	3.94
125	4.92
150	5.90
175	6.89
200	7.87
225	8.86
250	9.84
275	10.83
300	11.81

**VARIO 50 - 400**

mm	in
50	1.97
75	2.95
100	3.94
125	4.92
150	5.90
175	6.89
200	7.87
225	8.86
250	9.84
275	10.83
300	11.81
325	12.80
350	13.78
375	14.76
400	15.75



Scan the QRCode or click on it and watch the video to discover more about ROLLERI VARIO.



Download Rolleri **Bending App**.

Further to many interesting contents, the free app contains the tool for sheet metal development calculation and bending ruler.



Rolls - Rotating or fixed depending on version

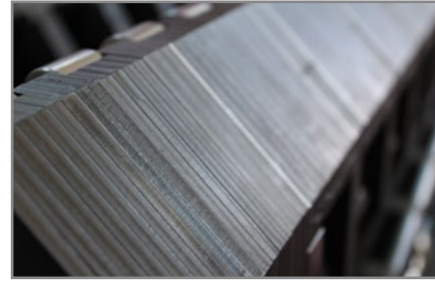

High resistance steel structure

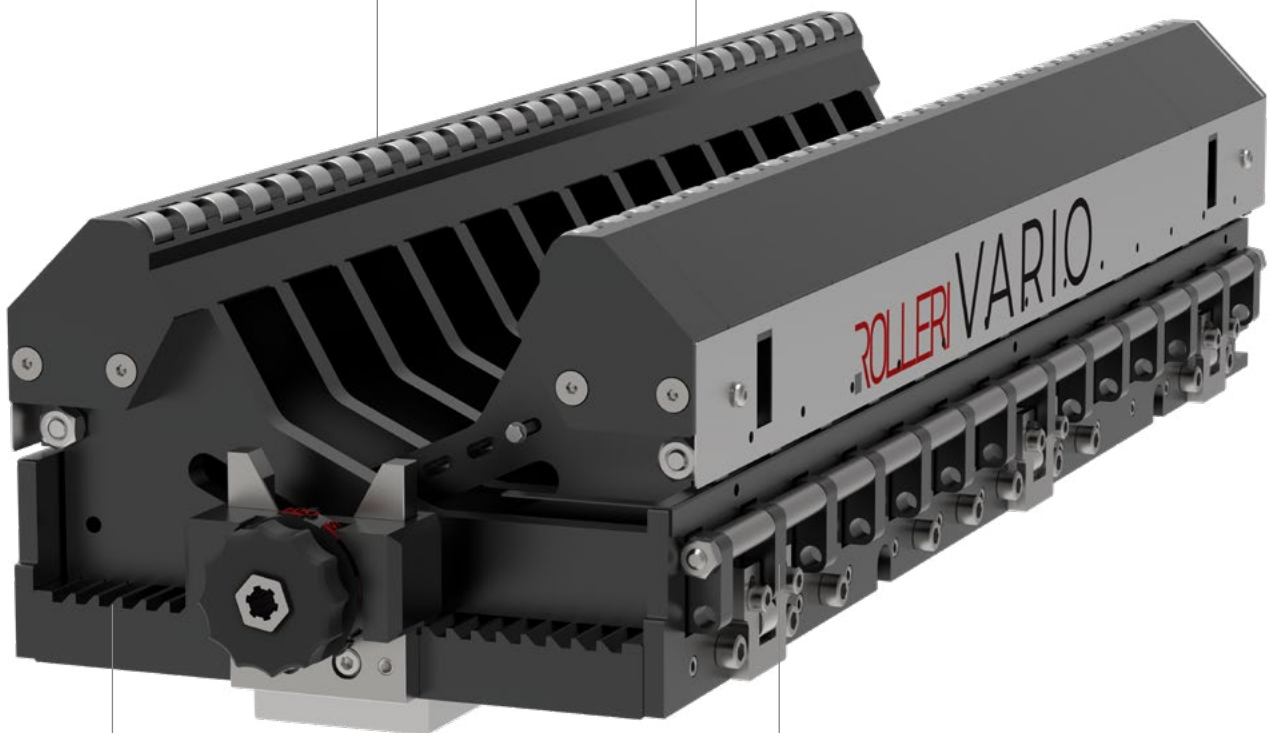

Generator plugged to CNC

Pneumatically operated positioning system



Create your account on [www.rolleritools.com](http://www.rolleritools.com)  
You can use Rolleri website to check the delivery time, request quotes, stay update with the news, check prices and place orders directly.



The **Bending handbook** target is to supply practice and useful information to reach quickly the required result. A lot of examples, easy formulas and information which explain the proper attitude towards the bending process.

AD dies can bend different sheet metal thickness types with one single die. V opening can be adjusted very easily and quickly and set by using spacer bars.

There are 4 models with different V opening range in order to bend different sheet metal thickness. V opening can be adjusted in 3 ways: manually, semiautomatically by using a starter or automatically with a motorized system.

The die structure is composed of 3 parts: the main frame which represents a die, a holder and spacer bars. The holder can be supplied with different tangs.

Spacer bars are inserted into the die sides to stop the V opening in a certain position. All AD dies have hardened rollers and can bend up to 30° in order to control better sheet metal springback.

To preserve die structure from dust and sheet metal residues, a die is supplied with a protection foil to be positioned into the V opening. Such operation is quick and simple.

A remarkable feature is their max. workload, which for some models reaches 6000 Kn/m. In order to set press brake CNC we can supply dxf drawings.

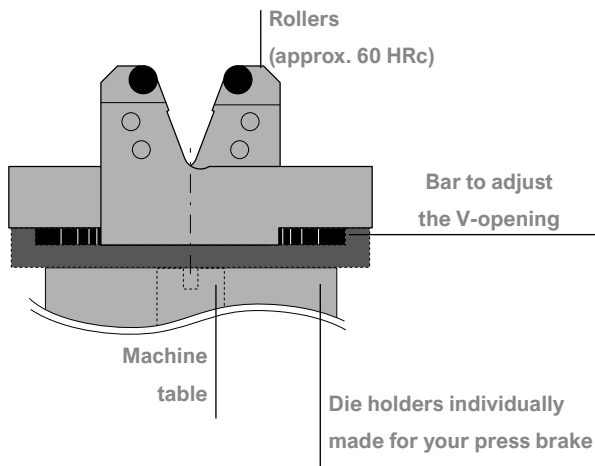

Protection foil available in different width to be placed into the V opening to protect it from dust and sheet metal residues.

Easy to be placed and it doesn't interfere during bending.



## AD25.125

250 mm	9.84"	34.0 kg
500 mm	19.69"	64.0 kg
550 mm	21.65"	72.0 kg
1000 mm	39.37"	125.0 kg
1050 mm	41.34"	133.0 kg

42Cr: 900-1150 N/mm<sup>2</sup>  
1250 kN/m max. (90°)

V	25-125 mm	0.98-4.92 in
°		30°-180°
R	8 mm	0.31 in

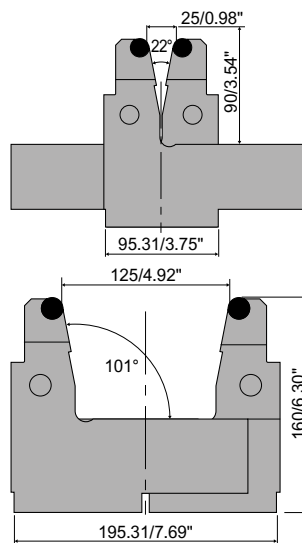

Download or ask for catalogues of punching tooling, ironworker, laser consumables, panel bending tooling and shear blades at [www.rolleritools.com/download](http://www.rolleritools.com/download)



The Bending handbook target is to supply practice and useful information to reach quickly the required result. A lot of examples, easy formulas and information which explain the proper attitude towards the bending process.

**AD65.185**

250 mm	9.84"	44.0 kg
500 mm	19.69"	86.0 kg
550 mm	21.65"	96.0 kg
1000 mm	39.37"	170.0 kg
1050 mm	41.34"	180.0 kg

42Cr: 900-1150 N/mm<sup>2</sup>  
2000 kN/m max. (90°)

V	65-185 mm	2.56-7.28 in
°		60°-180°
R	12.5 mm	0.49 in

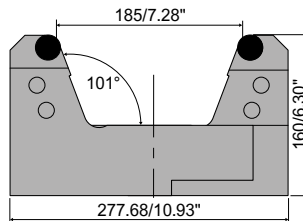
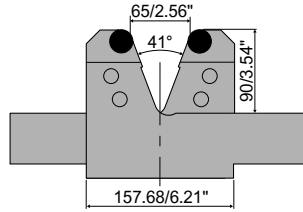
**AD120.300**

600 mm	23.62"	360.0 kg
--------	--------	----------

42Cr: 900-1150 N/mm<sup>2</sup>  
4000 kN/m max. (90°)

V	120-300 mm	4.72-11.81 in
°		60°-180°
R	20 mm	0.79 in

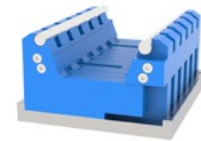
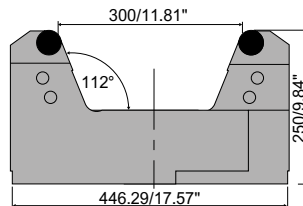
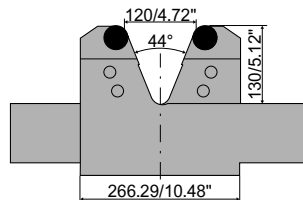
**AD150.400**

600 mm	23.62"	560.0 kg
--------	--------	----------

42Cr: 900-1150 N/mm<sup>2</sup>  
6000 kN/m max. (90°)

V	150-400 mm	5.91-15.75 in
°		60°-180°
R	25 mm	0.98 in

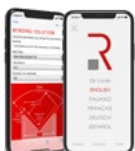
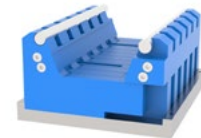
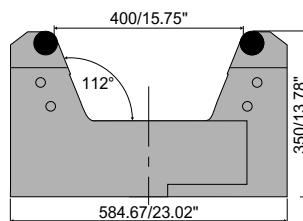
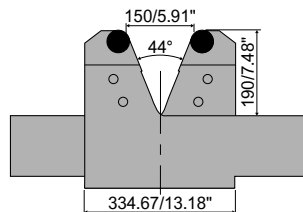
**Download Roller Bending App.**

You will have access to our online store where you can get what you need. You will also get our sheet metal unfolding software for free and our bending rule.

**Create your account on [www.rolleritools.com](http://www.rolleritools.com)**

You can use Roller website to check the delivery time, request quotes, stay update with the news, check prices and place orders directly.

**BAR AD25.185**

500 mm	19.69"	21.0 kg
1000 mm	39.37"	42.0 kg
2000 mm	78.74"	84.0 kg



42Cr: 900-1150 N/mm<sup>2</sup>

Set spacer bars width:

2-5-10-15-20-30-40-50

To use with:

AD25.125 - AD65.185

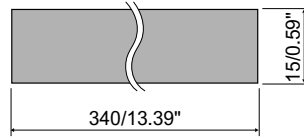

**BAR AD120.300**

600 mm	23.62"	45.0 kg
1200 mm	47.24"	90.0 kg
1800 mm	70.78"	135.0 kg



42Cr: 900-1150 N/mm<sup>2</sup>

Set spacer bars width:

2-5-10-15-20-30-40-50-60

To use with:

AD120.300

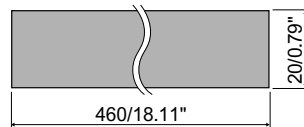

**BAR AD150.400**

600 mm	23.62"	55.0 kg
1200 mm	47.24"	110.0 kg
1800 mm	70.78"	165.0 kg



42Cr: 900-1150 N/mm<sup>2</sup>

Set spacer bars width:

5-10-15-20-30-40-50-60

To use with:

AD150.400

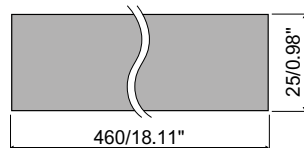

Create your account on [www.rolleritools.com](http://www.rolleritools.com)  
 You can use Rolleri website to check the delivery time, request quotes, stay update with the news, check prices and place orders directly.



Download Rolleri Bending App.

You will have access to our online store where you can get what you need. You will also get our sheet metal unfolding software for free and our bending rule.



**HAD25.125-A**

500 mm	19.69"	20 kg
1000 mm	39.37"	40 kg
2000 mm	78.74"	80 kg
3000 mm	118.11"	120 kg

42Cr: 900-1150 N/mm<sup>2</sup>

Holders available with flat

bottom and with tang

To use with:

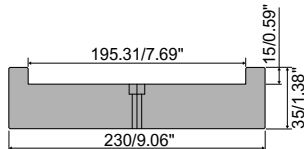
AD25.125**HAD25.125-B**

500 mm	19.69"	38 kg
1000 mm	39.37"	76 kg
2000 mm	78.74"	152 kg
3000 mm	118.11"	228 kg

42Cr: 900-1150 N/mm<sup>2</sup>

Holders available with flat

bottom and with tang

To use with:

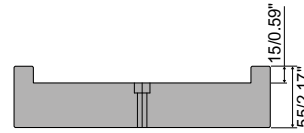
AD25.125**HAD65.185-A**

500 mm	19.69"	28 kg
1000 mm	39.37"	56 kg
2000 mm	78.74"	112 kg
3000 mm	118.11"	168 kg

42Cr: 900-1150 N/mm<sup>2</sup>

Holders available with flat

bottom and with tang

To use with:

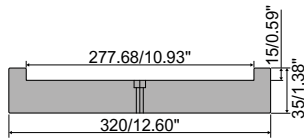
AD65.185**HAD65.185-B**

500 mm	19.69"	53 kg
1000 mm	39.37"	106 kg
2000 mm	78.74"	212 kg
3000 mm	118.11"	424 kg

42Cr: 900-1150 N/mm<sup>2</sup>

Holders available with flat

bottom and with tang

To use with:

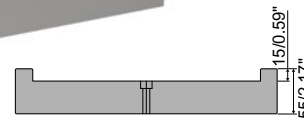
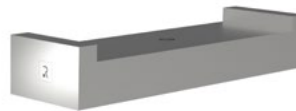
AD65.185**HAD120.300**

600 mm	23.62"	99.0 kg
1200 mm	47.24"	198.0 kg
2400 mm	94.49"	396.0 kg
3000 mm	118.11"	495.0 kg

42Cr: 900-1150 N/mm<sup>2</sup>

Holder available with flat

bottom:

To use with:

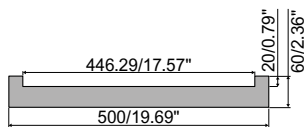
AD120.300**HAD150.400**

600 mm	23.62"	230 kg
1200 mm	47.24"	460 kg
2400 mm	94.49"	920 kg
3000 mm	118.11"	1.150 kg

42Cr: 900-1150 N/mm<sup>2</sup>

Holder available with flat

bottom:

To use with:

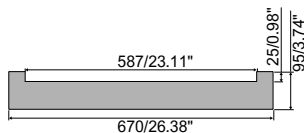
AD150.400

The Bending handbook target is to supply practice and useful information to reach quickly the required result. A lot of examples, easy formulas and information which explain the proper attitude towards the bending process.



Create your account on [www.rolleritools.com](http://www.rolleritools.com)  
You can use Rolleri website to check the delivery time, request quotes, stay update with the news, check prices and place orders directly.

Dies with rollers are an effective solution to reduce sheet metal marks, thanks to their hardened and ground rollers which slide sheet metal into the V opening.

Roller rotation reduces friction and subsequently necessary tonnage by about 10-15-%.

Roller seat is machined to avoid accidental fall of rollers. All dies are made of 42CrMo4 steel and they can be manufactured with any tang to be clamped in press brake table. In order to control better springback, all die V openings have 78°.

Available tangs:

A11

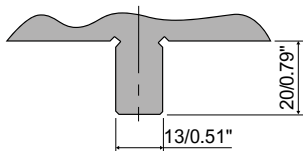

A13

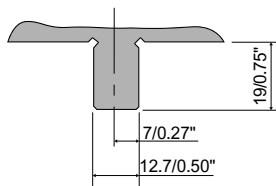

A10

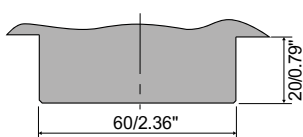

The **Bending handbook** target is to supply practice and useful information to reach quickly the required result. A lot of examples, easy formulas and information which explain the proper attitude towards the bending process.



Download Roller Bending App.

You will have access to our online store where you can get what you need. You will also get our sheet metal unfolding software for free and our bending rule.

## MR90

	V		B		C		Lenght		
	mm	in	mm	in	mm	in	mm	in	kg
MR90.20.78	20	0.79	45	1.77	6	0.24	835	32.87	15.0
MR90.24.78	24	0.94	49	1.93	6	0.24	835	32.87	17.0
MR90.30.78	30	1.18	60	2.36	8	0.31	835	32.87	21.0
MR90.40.78	40	1.57	70	2.76	8	0.31	835	32.87	24.0
MR90.50.78	50	1.97	84	3.31	10	0.39	835	32.87	28.0
MR90.60.78	60	2.36	94	3.70	10	0.39	835	32.87	31.0
MR90.70.78	70	2.76	104	4.09	10	0.39	835	32.87	35.0

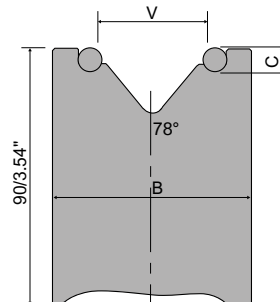
42Cr: 900-1150 N/mm<sup>2</sup>Roller: C53:610-760 N/mm<sup>2</sup>

## MR130

	V		B		C		Lenght		
	mm	in	mm	in	mm	in	mm	in	kg
MR130.20.78	20	0.79	45	1.77	6	0.24	835	32.87	22.0
MR130.24.78	24	0.94	49	1.93	6	0.24	835	32.87	25.0
MR130.30.78	30	1.18	60	2.36	8	0.31	835	32.87	28.0
MR130.40.78	40	1.57	70	2.76	8	0.31	835	32.87	34.0
MR130.50.78	50	1.97	84	3.31	10	0.39	835	32.87	40.0
MR130.60.78	60	2.36	94	3.70	10	0.39	835	32.87	45.0
MR130.75.78	75	2.95	118	4.65	16	0.63	835	32.87	50.0
MR130.80.78	80	3.15	123	4.84	16	0.63	835	32.87	55.0
MR130.90.78	90	3.54	133	5.24	16	0.63	835	32.87	60.0
MR130.100.78	100	3.94	143	5.63	16	0.63	835	32.87	65.0
MR130.120.78	120	4.72	163	6.42	16	0.63	835	32.87	70.0

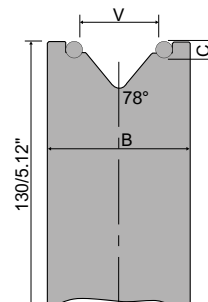
42Cr: 900-1150 N/mm<sup>2</sup>Roller: C53:610-760 N/mm<sup>2</sup>

Download or ask for catalogues of punching tooling, ironworker, laser consumables, panel bending tooling and shear blades at [www.rolleritools.com/download](http://www.rolleritools.com/download)



Create your account on [www.rolleritools.com](http://www.rolleritools.com)  
You can use Rolleri website to check the delivery time, request quotes, stay update with the news, check prices and place orders directly.

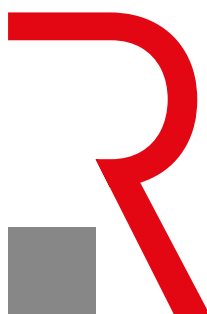

English edition 1.0 | 2020

**Rolleri S.p.A.**

Via Artigiani · Loc. Cabina · 29020

Vigolzone (PC) · Italy

Tel. +39 0523 870905

Fax +39 0523 879030

[www.rolleritools.com](http://www.rolleritools.com)

[sales@rolleri.it](mailto:sales@rolleri.it)

**in**

*linkedin*

**f**

*facebook*



*instagram*



*twitter*

**You  
Tube**

*youtube*



*vimeo*